

# MPP- Solar charge controller SMR2000

## Description:

The SMR2000 consists of 4x SMR500-MPP-Modules, of 1 Master and 3 slaves. The charge current and consumer current is divided 1:1:1:1. The factory adjusts the exact proportion of current for each module. This charger, in processor technique, contains all functions for smooth charging of lead Battery by solar modules of 1120Wp at 12V- and 2240Wp at 24V-Systems. Because of the powertracking it is possible to increase the electrical power of a solar system up to 40%, than standart charger can do. The maximum solar voltage can be for a 12V-system as well as for a 24V-system and 48V-System 150V. (Open circuit voltage) Its inherent buck converter feeds the maximum possible current from the power maximum of the solar modul into the Battery. As soon as the Battery is full and reaches its maximum voltage (14.5V/29.0V/58.0V) the charger drives the solar voltage towards open circuit voltage, preventing overcharging of the Battery. A yellow LED indicates this state of charge. Deep discharge protection is activated with 60 Seconds delay. Switching is done by a Power Mosfet on the ground level. The indication of the consumer switch off state is done by a red LED. The green LED indicates solar current. A temperature sensor tracks the maximum Battery voltage at  $-4mV/^{\circ}C$ /Battery cell. The powertracking system is utilized every 8 seconds to optimize the solar power point. A battery management system allows adaptation to different battery types and optimal use of the battery capacity, including an automatic and manual equalization control.

### Highlights:

- \* DC-Converter to optimize solar power income
- \* MPP-Tracking of solar voltage
- \* Selection of 3 Battery voltages 12V/24V/48V
- \* Indication of state of charge per LED
- \* Deep discharge protection
- \* Temperature tracking of Battery voltage
- \* Battery management system
- \* Option: LCD for Battery voltage, -current, -power

## Technical data

	12V-Akku	24V-Akku	48V-Akku
Max. solar open circuit voltage, $U_{soc}$	150V	150V	150V
Max. solar current	80A	80A	50A
Max. charge current	80A	80A	50A
Max. solar power, $P_{nom}$	1120Wp	2240Wp	2820Wp
Efficiency	Ca. 93% bei Halblast	Ca. 96% bei Halblast	Ca. 96% bei Halblast
Deep discharge protection			
Load disconnect	10.8V	21.6V	43.2V
Load reconnect	12.5V with 60 seconds delay	25.0V with 60 seconds delay	50.0V with 60 seconds delay
Current consumption	12mA	12mA	12mA
<b>Terminals:</b>			
2x Solar generator	25sqmm/16sqmm		
2x Battery output	25sqmm/16sqmm		
2x consumer output	25sqmm/16sqmm		
2x temperature sensor	1.5sqmm		
Temperatur sensor	KTY10-5 or 1.91kOhm		
Cable glands	3x PG16, 1x PG7		
LED's	right: yellow (Indication of max Battery voltage) left: green (Battery current > 0.5A) middle: red (consumer off)		
housing	Steel wall mounted wxhxd 300x400x150mm		
protection	IP55		
weight	15.5kg		
Moisture	90% (coating)		
Operating Temperature	$-20^{\circ}C$ bis $+50^{\circ}C$		

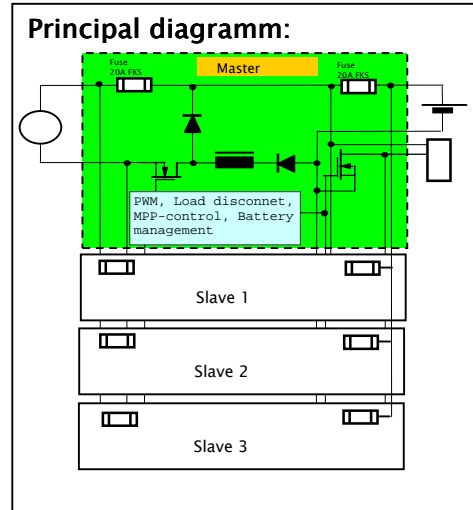
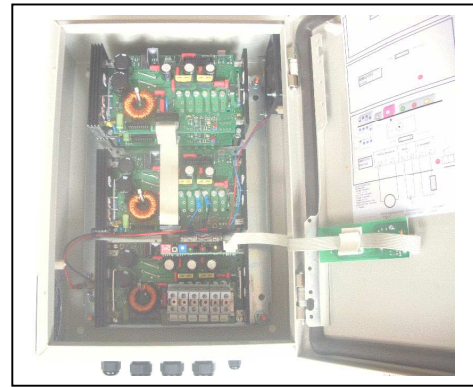

Battery current vs Battery voltage

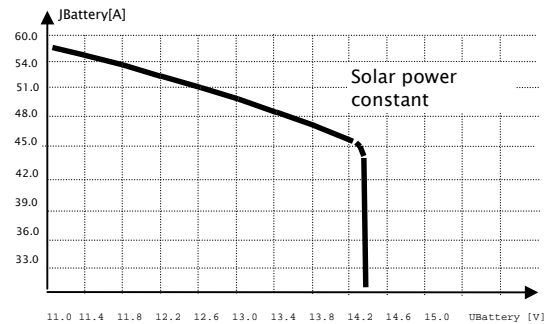

Effectivity vs solar power

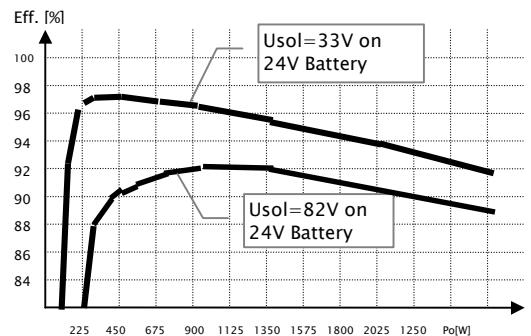

Technical data are subject to change

**Housing dimensions (mm):**

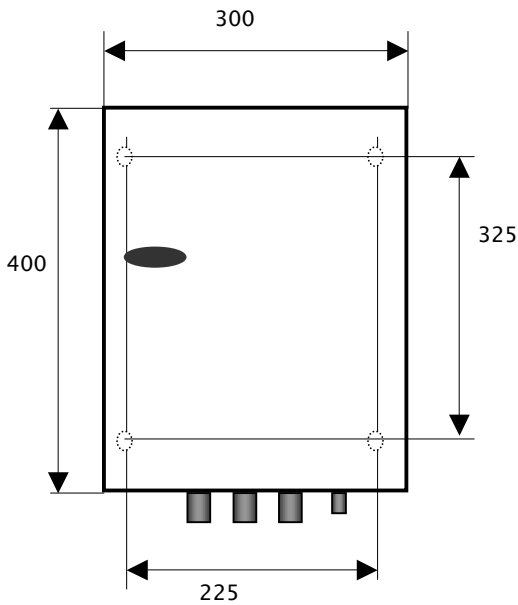

Height=150mm  
 Mounting holes in bottom of housing  
 D=10mm

**Connection diagram**

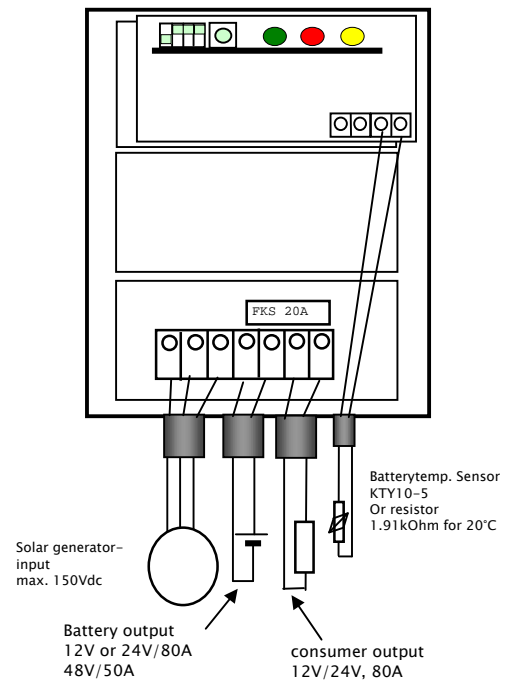

**Applications:**

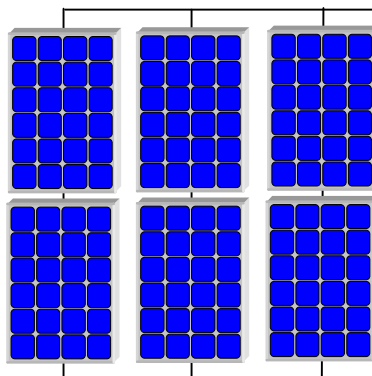

**Configuration with optimum efficiency:**

2 Modules string, 72 cells.  
 $U_{mpp}=34V$ ,  $U_{soc}=41.5V$   
 $P_{nom}=2240Wp$ ,  
 Efficiency=96% at 0.1Pnom  
 95% at 0.5Pnom, 92% at 1Pnom  
 24V-Battery system,  $I_{Battery}=80A$

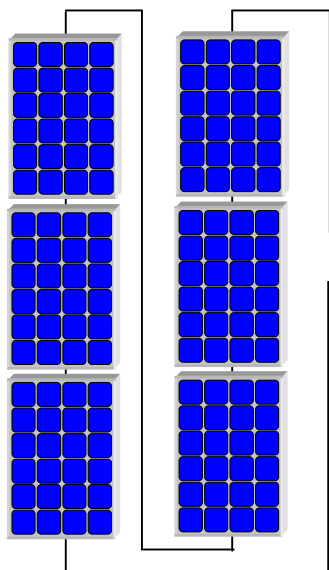
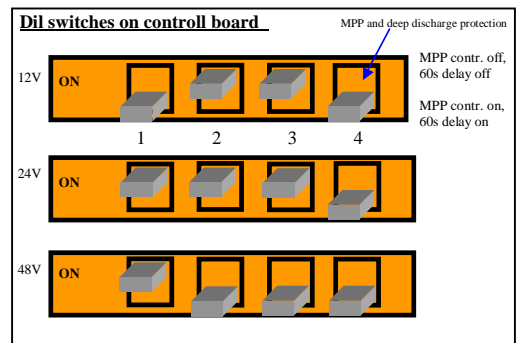
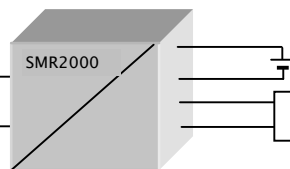

**Configuration with maximum Solarvoltage:**

6 Modules string, 216 Cells.  
 $U_{mpp}=102V$ ,  $U_{soc}=124V$   
 $P_{nom}=2240Wp$ ,  
 Efficiency=81% at 0.1Pnom  
 91% at 0.5Pnom, 89% at 1Pnom  
 24V-Battery system,  
 $I_{Battery}=80A$

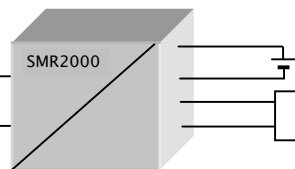

Technical data are subject to change